

SubstiTUBE® Advanced EM T8 SO

ST8A-0.6M-8.7W

ST8A-1.2M-17.5W

ST8A-1.5M-20W



Technical Features

- Wide voltage input: 100-240 VAC; 50/60 Hz
- T8 LED tube made of glass with G13 base
- Weight: <500g
- Replace for fluorescent T8 tube
- Up to 50,000 h lifetime (L70B50)
- CCT: 3000k, 4000K, 6500K
- Length: 2FT (0.6m) / 4FT(1.2m) / 5FT(1.5m)

Electrical and photometric data (rated value)

	Voltage [V]	Frequency [Hz]	Power (100%) [W]	Lumen Flux(100%) [lm]	CCT [K]	PF	CRI (Ra)
ST8A-0.6M 8.7W/830 100-240V EM	100-240	50/60	8.7	945	3000	0.9	80
ST8A-0.6M 8.7W/840 100-240V EM	100-240	50/60	8.7	1050	4000	0.9	80
ST8A-0.6M 8.7W/865 100-240V EM	100-240	50/60	8.7	1050	6500	0.9	80
ST8A-1.2M 17.5W/830 100-240V EM	100-240	50/60	17.5	1800	3000	0.9	80
ST8A-1.2M 17.5W/840 100-240V EM	100-240	50/60	17.5	2100	4000	0.9	80
ST8A-1.2M 17.5W/865 100-240V EM	100-240	50/60	17.5	2100	6500	0.9	80
ST8A-1.5M 20W/830 100-240V EM	100-240	50/60	20	2160	3000	0.9	80
ST8A-1.5M 20W/840 100-240V EM	100-240	50/60	20	2400	4000	0.9	80
ST8A-1.5M 20W/865 100-240V EM	100-240	50/60	20	2400	6500	0.9	80

1. All technical parameters apply to the entire lamp. Because of the complex manufacturing process for light-emitting diodes (LEDs), the specified typical values for LED technical parameters represent only purely statistical variables. They do not necessarily correspond to the actual technical parameters for each individual product which can deviate from the typical value. For parameter of Lumen and Watt, production control tolerance with $\pm 10\%$ in delivery.
2. L70B50 is the average operating life of the LED Lamp during which the luminous flux is greater than or equal to 70% of the initial luminous flux, for 50% of the population. The lifetime is estimated at room temperature (25deg C), free air burning, base up position.

Benefit:

innovative LED-lamp, easy and safe to use with CCG retrofit and AC direct input

High lumen efficacy, providing excellent energy saving comparing to traditional FL T8

Lower maintenance cost thanks to longer lifetime than traditional Fluorescent.

Quick, simple and safe replacement. Correct operation temperature -20° ... $+45^{\circ}$ C

Application:

- Train Station
- Underground subway
- Supermarket, retail store
- Parking lot
- Office

**Minimum /
Maximum
ratings**
Ambient temperature T_a Maximum temperature T_c Storage temperature T_s
[°C]

ST8A-0.6M-8.7W	-20~45°C	<75 °C	-20°... 80°C
ST8A-1.2M-17.5W	-20~45°C	<75 °C	-20°... 80°C
ST8A-1.5M-20W	-20~45°C	<75 °C	-20°... 80°C

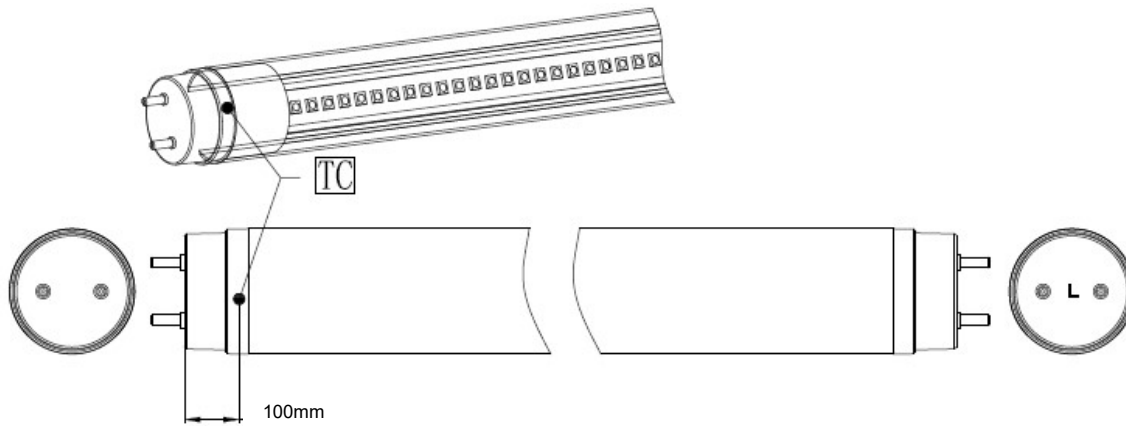

Models	A (mm)	B (mm)	C (mm)	D (mm)	Net Weight (g)
ST8A-0.6M-8.7W	≤589.8	≤596.9	≤604	≤28	<500
ST8A-1.2M-17.5W	≤1199.4	≤1206.5	≤1213.6	≤28	<500
ST8A-1.5M-20W	≤1500	≤1507.1	≤1514.2	≤28	<500

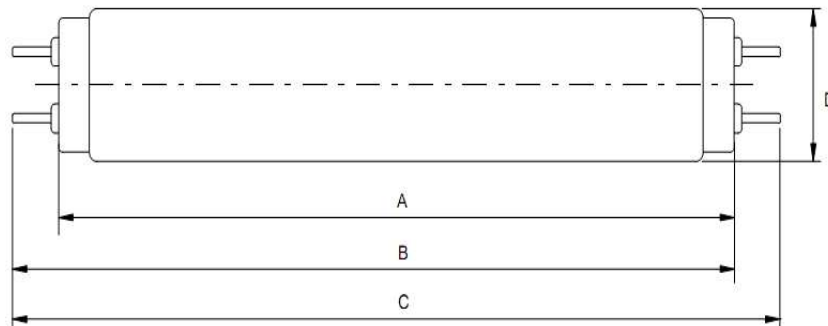
Common Characteristics

Lifetime @L70B50 (hrs) ²	Color Rendering Index	SDCM	Beam Angle (50% light intensity)	Operating Temp.(°C)
50,000	≥80	≤6	>160°	-20 ~ +45
Start up time (s)	Tube material	Weight(g)	PF	Dimming
<0.5	glass	<500	>0.9	NO

Safety and application notes

- The SubstiTUBE® Advanced EM T8 SO Tube must be handled with care. Do not operate product in a damaged condition.
- When operating with double side input wiring, SubstiTUBE® Starter has to be inserted to replace the conventional fluorescent lamp starter. If the conventional starter is not replaced, the SubstiTUBE® Advanced EM T8 SO Tube will start blinking and be damaged!
- Do not use SubstiTUBE® Advanced EM T8 SO Tube in luminaires which do not have any conventional starter or whereby the conventional starter cannot be replaced. Otherwise, rewiring is needed.
- Not suitable for luminaires with serial lamp connection i.e. more than one tube at one magnetic ballast.
- The SubstiTUBE® Advanced EM T8 SO Tube emits light at a limited angle, unlike conventional fluorescent tubes in 360° omni-direction.
- Due to the light distribution characteristic of the SubstiTUBE® Advanced EM T8 SO Tube the resulting luminaires light characteristic is likely to change. It is not guaranteed that e.g. standards for lighting at working places will be complied with after replacement. A photometric check of the installation is highly recommended.
- The effective energy savings depend on the efficiency of the luminaire setup to be replaced and should be considered individually in each case. Particularly magnetic ballast losses are reduced to ohmic losses and are normally only about 1W.
- The SubstiTUBE® Advanced EM T8 SO Tube is protected according to IP20. Applications with external risk of moisture and dust can be served with an adequately protected luminaire.
- SubstiTUBE® Advanced EM T8 SO Tube products differ in their diameters and geometries from fluorescent lamps. Their use in open batten luminaires with gaskets is possible if no excessive force is expended during the fixing. Obtaining the necessary IP protection in open batten luminaires with gaskets cannot be ensured.
- SubstiTUBE® Advanced EM T8 SO Tube can be driven directly on line voltage. In order to grant a safe operation mode please refer to the installation instructions for further information.
- Photobiological Safety of lamps and lamp systems according to IEC 62471. Risk Group: Exempt

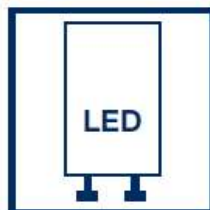

Dimming not allowed

Lamp suitable for
50 Hz or 60 Hz
operationLED replacement
starterLamp to be used in
dry conditions or
in a luminaire that
provides protectionLamp not suitable for
emergency operation

Installation Guide

1) Retrofitting a CCG luminaire accord. to EN 62776

Replacing fluorescent T8 tube and installed starter by SubstiTUBE® Advanced EM T8 SO Tube and SubstiTUBE® Starter

Below is an example for typical lamp holder types

- ✓ Please ensure that the voltage supply is disconnected.
- ✓ Carefully remove the fluorescent tube and conventional starter according to the lamp holder type
- ✓ Insert SubstiTUBE® Advanced EM T8 SO Tube and SubstiTUBE® Starter properly.

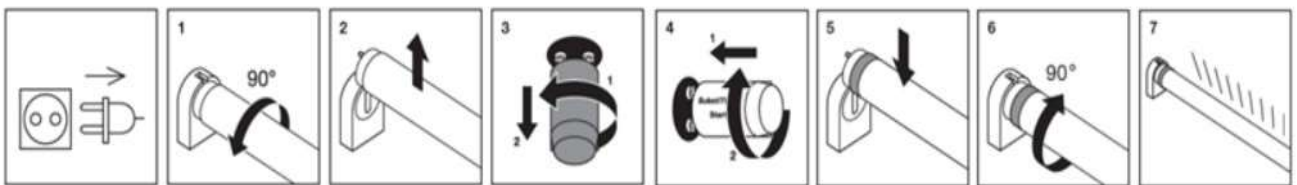

- ✓ Turn the conventional lamp 90° and take it out of the socket.
- ✓ Remove the conventional starter by turning it.
- ✓ Insert and latch the SubstiTUBE® Starter into starter socket.
- ✓ Insert SubstiTUBE® Advanced EM T8 SO Tube into socket and locate into position by turning 90°.
- ✓ Check light the emission direction

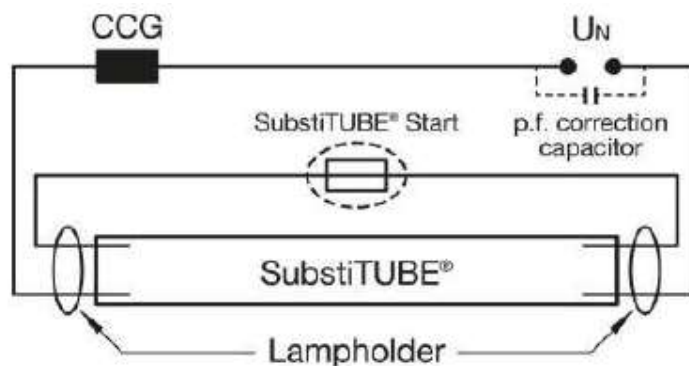

Circuit diagram of a retrofitted CCG luminaire

NOTE: If a luminaire contains a power factor correction capacitor, it is recommended to remove it from the circuit to maintain power factor >0.9. This should only be carried out by a licensed electrician.

Installation Guide

2) Installation directly on line voltage

SubstiTUBE® Advanced EM T8 SO Tube may also be driven directly on line voltage. **Please check the L/N markings on the LED tube.** In order to grant a safe operation mode please refer to the installation instructions for further information. Installation must be done by licensed electricians.

2.1) Two different wiring configurations for single tube

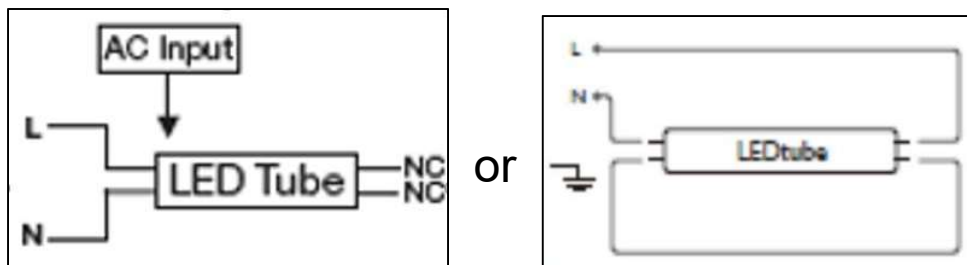

2.2) Two different wiring configurations for double tubes.

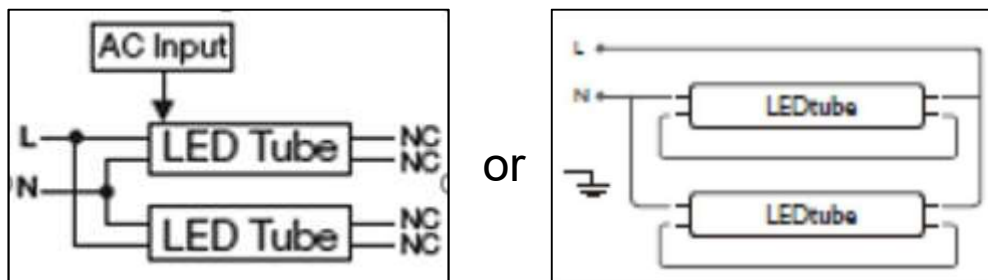

3) Installation of an ECG luminaire with EM tube

WARNING: SubstiTUBE® Advanced EM T8 SO Tube is not compatible for use with electronic control gear (ECG). If there is an existing ECG, bypass the ballast and re-wire* according to “2) Installation directly on line voltage” and diagrams above.

***WARNING:** Modifications to the wiring of an existing luminaire must be carried out by qualified personnel only. Any modifications made to the original luminaire will alter the safety aspects of the original luminaire; hence compliance certification of the original luminaire will no longer be applicable to the modified luminaire.

Installation Guide

CAUTIONS: Installation Instructions for SubstiTUBE® Advanced EM T8 SO Tube
Connect both line (L) and neutral (N) power to one lampholder as below diagram.

Tube side with the marking “AC input” around the cap should be facing the lampholder with mains connection
otherwise the lamps will not be functionally ON, and AC line in might short circuit.

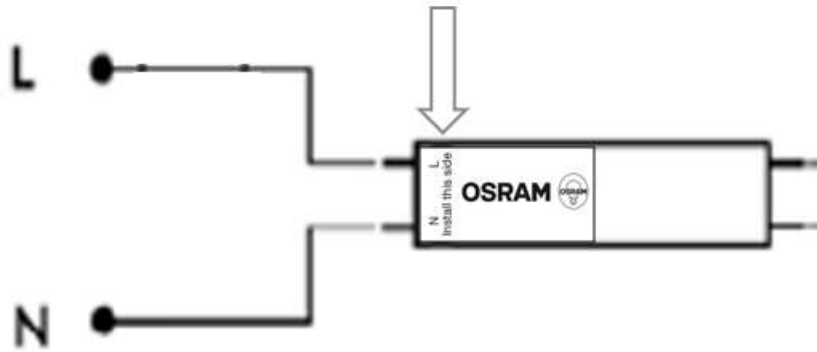

Ordering Guide

Product	EAN-10*	EAN-40**	S-Unit***
ST8A-0.6M 8.7W/830	4058075353343	4058075353350	25X1
ST8A-0.6M 8.7W/840	4058075353367	4058075353374	25X1
ST8A-0.6M 8.7W/865	4058075353381	4058075353398	25X1
ST8A-1.2M 17.5W/830	4058075353404	4058075353411	25X1
ST8A-1.2M 17.5W/840	4058075353428	4058075353435	25X1
ST8A-1.2M 17.5W/865	4058075353442	4058075353459	25X1
ST8A-1.5M 20W/830	4058075353466	4058075353473	25X1
ST8A-1.5M 20W/840	4058075353480	4058075353497	25X1
ST8A-1.5M 20W/865	4058075353503	4058075353510	25X1

* EAN-10: ordering code for single unit

** EAN-40: ordering code for shipping unit

*** S-Unit: Lamps per shipping unit

Sales and Technical Support

Sales and technical support is given by the local subsidiaries.

On our worldwide homepage all subsidiaries are listed with complete address and phone numbers.

WWW.osram-lamps.com/substitube

Head Office:

Parkring 33, 85748
Garching/Munich
Germany